

BUSH

Instruction manual



Contents

1 Safety information

Safety information 6

2 Getting to know your washer-drier

Ready? Let's begin 10

Accessories 12

3 Installing your washer-drier

Installation requirements 14

Unpacking 14

Connections (electrical, water, gas) 15

4 Functions

Functions 18

5 Using your washer-drier

First use of washer-drier 24

Standard and advanced functions/use 25

6 Care and Maintenance

Cleaning 30

Maintenance actions 30

Technical specifications 32

7 Product support

Troubleshooting 34

Help and assistance 35

Declaration of conformance to product standards 36

Disposal 37

Safety information

1





Safety information

Important - Please read these instructions fully before installing or operating

- If the supply cord is damaged, it must be replaced by the manufacturer, its service agent or similarly qualified persons in order to avoid a hazard.
- The new hose-sets supplied with the appliance are to be used and that old hose-sets should not be reused.
- This washer-drier is for indoor use only.
- The openings must not be obstructed by a carpet.
- This appliance can be used by children aged from 8 years and above and persons with reduced physical, sensory or mental capabilities or lack of experience and knowledge if they have been given supervision or instruction concerning use of the appliance in a safe way and understand the hazards involved.
Cleaning and maintenance shall not be made by children without supervision.
- This appliance is not intended for use by persons (including children) with reduced physical, sensory or mental capabilities, or lack of experience and knowledge, unless they have been given supervision or instruction concerning use of the appliance by a person responsible for their safety.
- Pull out its plug from the power socket before cleaning or maintenance.
- Make sure that all pockets are emptied.
- Sharp and rigid items such as coin, brooch, nail, screw or stone etc. may cause serious damages to this machine.
- Pull out its plug and cut off water supply after the operation.
- Please check whether the water inside the drum has been drained before opening its door. Please do not open the door if there is any water visible.
- Pets and children may climb into the machine. Check the machine before every operation.
- Glass door may be very hot during the operation. Keep children and pets far away from the machine during the operation.
- Take care that power voltage and frequency shall be identical to those of washer-drier.
- Do not use any socket with rated current less than that of washer-drier. Never pull out power plug with wet hand.
- To ensure your safety, power cord plug must be inserted into an earthed three-pole socket. Check carefully and make sure that your socket is properly and reliably earthed.

If you require any technical guidance or find that your product is not operating as intended, a simple solution can often be found in the **Troubleshooting** section of these instructions.



Safety information

Important - Please read these instructions fully before installing or operating

- Children of less than 3 years should be kept away unless continuously supervised.
- Do not let kids play with the machine.
- Packing materials may be dangerous to the children. Please keep all packing materials (plastic bags, foams etc) far away from the children.
- Washer-drier shall not be installed in bath room or very wet rooms as well as in the rooms with explosive or caustic gases.
- Make sure that the water and electrical devices must be connected by a qualified technician in accordance with the manufacturer's instructions and local safety regulations.
- Before operating this machine, all packages and transport bolts must be removed. Otherwise, the washer-drier may be seriously damaged while washing the clothes.
- Before washing the clothes at first time, the washer-drier shall be operated in one round of the whole procedures without the clothes inside.
- The washer-drier with single inlet valve only can be connected to the cold water supply. The washer-drier with double inlet valves can be connected to the hot water and cold water supply.
- Your washer-drier is only for home use and is only designed for the textiles suitable for machine washing.
- Flammable and explosive or toxic solvents are forbidden. Gasoline and alcohol etc. Shall not be used as detergents. Please only select the detergents suitable for washer-drier, especially for drum.
- Be careful of burning when washer-drier drains hot washing water. Never refill the water by hand during washing.
- After the program is completed, Please wait for two minutes to open the door.
- Please remember to disconnect water and power supply immediately after the clothes are washed.
- Do not climb up and sit on top cover of the machine.
Do not lean against machine door.
- Please do not close the door with excessive forces. If it is found difficult to close the door, please check if the excessive clothes are put in or distributed well.
- The household washer-drier isn't intended to be built-in.
- Cautions during Handling Machine
 1. Transport bolts shall be reinstalled to the machine by a specialized person.
 2. The accumulated water shall be drained out of the machine.
 3. Handle the machine carefully.
- Never hold each protruded part on the machine while lifting. Machine door can not be used as the handle during the conveyance.

Getting to know your washer-drier

2



Getting to know your washer-drier

You'll be up and running in no time

Ready? Let's begin...

Please read these instructions carefully. They contain important information which will help you get the best from your washer-drier and ensure safe and correct installation and operation.

If you require any further assistance, our technical experts are happy to help. For full details, refer to the product support section at the end of these instructions.

Getting to know your washer-drier

You'll be up and running in no time

Component

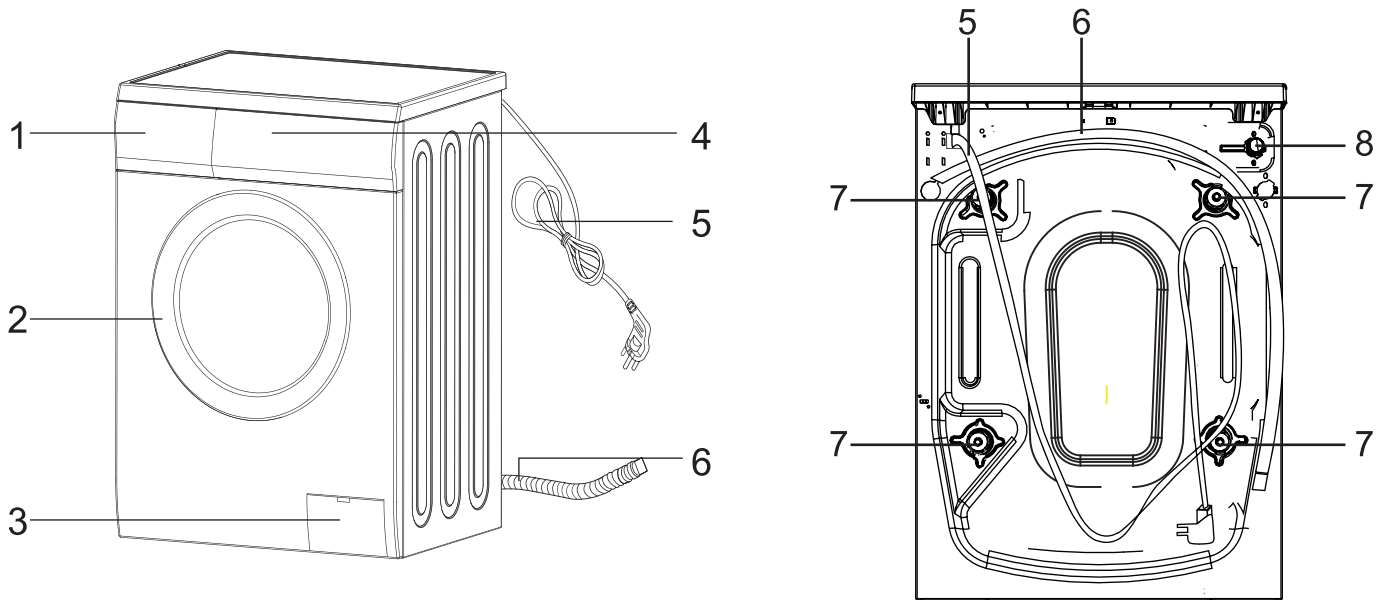

1.Detergent Drawer

2.Door

3.Filter

4.Control Panel

5.Power lead

6.Drain hose

7.Transport bolt x 4

8.Water inlet

Getting to know your washer-drier

You'll be up and running in no time

Model	capacity	Spin Speed	Energy class
NWDH8XWD	8kg	1400rpm	A

Accessories

This machine includes below accessories, please install these parts by yourself before operating.

- plastic hole plug x 4
- Inlet hose

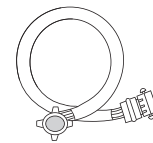
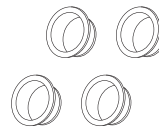

Tools

You may use this tools to help install above parts

- glove
- spanner

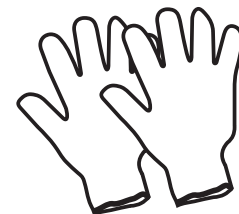
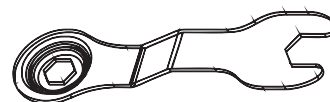

If you require any technical guidance or find that your product is not operating as intended, a simple solution can often be found in the **Troubleshooting** section of these instructions.

Installing your washer-drier

3



Installing your washer-drier

Bringing it all together

Installation requirements

- In addition to the instructions mentioned here, special regulations of the relevant water and companies may apply. If in doubt, have the washer-drier connected by a qualified technician.
 - The washer-drier is heavy - caution when lifting it.
 - Do not lift by projecting components (e.g. washer-drier door).
 - Warning: Frozen hoses may tear/burst. Do not install washer-drier in outdoor areas or where there is a risk of frost. Please operate washer-drier above 0°C.
 - Lay hoses and cables in such a way that there is no risk of tripping over them.
- ⚠ An additional space (approximately 120mm) is required at the rear of the washer-drier. This is to allow enough space for the water hose and drain hose connections.
- Dimension of the machine with door open.

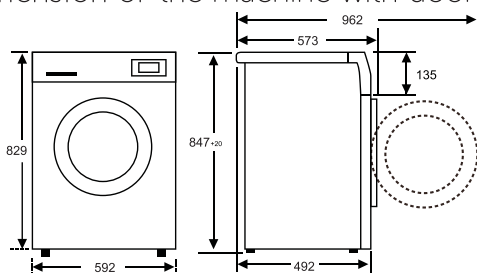

Unpacking

Unpacking your washing machine

Caution: 2 people are required to unpack the washing machine, it is recommended that gloves are worn.

Carefully remove all packing materials including the foam base, dispose of correctly.

Note: When opened, water droplets may be visible in the drum etc. this is normal as each appliance is tested before delivery.

Removing the transport bolts

Important: The transport bolts are designed to support the internal components during transit these MUST be removed before use.

- 1: Loosen the screws by rotating counterclockwise with a suitable wrench, (Fig 1 - 2)
- 2: Remove the bolts by pulling them. (Fig 3)
- 3: When the transport bolts have been removed, insert the plastic transport screw taps found in the accessories bag into the holes. (Fig 4)

If you require any technical guidance or find that your product is not operating as intended, a simple solution can often be found in the **Troubleshooting** section of these instructions.

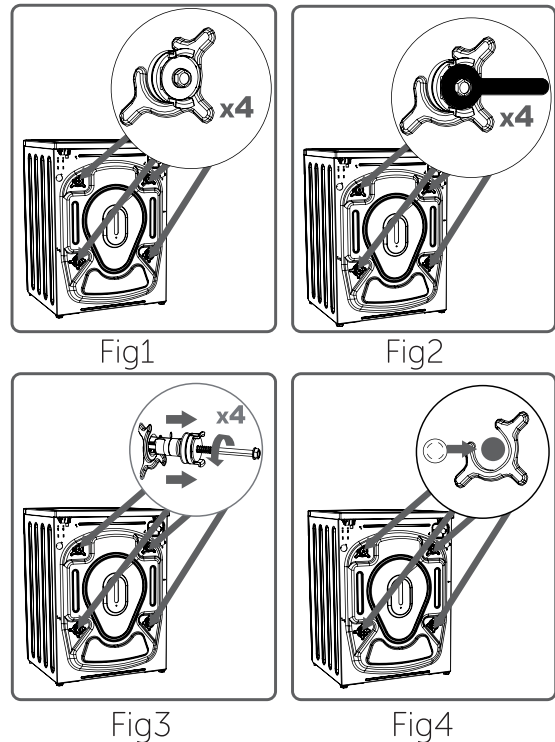

Levelling feet

- 1: For your machine to work efficiently with minimum vibration it should be settled on flat, nonslippery, firm ground.
- 2: You can adjust the balance of your machine by changing the positioning of its feet.
- 3: First, loosen the plastic adjustment nut. (Fig 5)
- 4: Adjust by rotating the feet upwards or downwards. (Fig 6)
- 5: After the desired position has been reached, tighten the plastic adjustment nut again by rotating it upwards.

Note: Never put cartons, wooden blocks or similar materials under the machine to balance irregularities in the level of the ground.

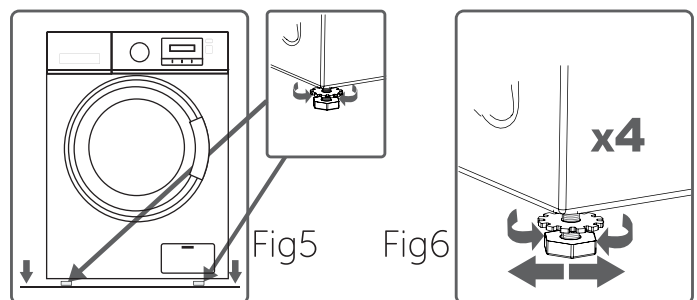

Installing your washer-drier

Bringing it all together

Connections

Water inlet hose connections

Important: This washer-drier **MUST** only be connected to a cold water supply.

1: Connect the water inlet hose, the angled connection attaches to the water inlet on the back of the washer-drier. (Fig 7)

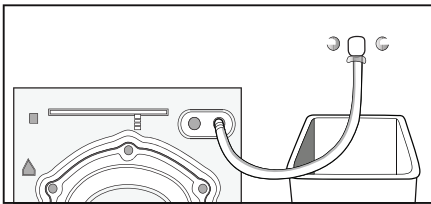

Fig7

2: The straight connection attaches to the water supply valve. (Fig 8)

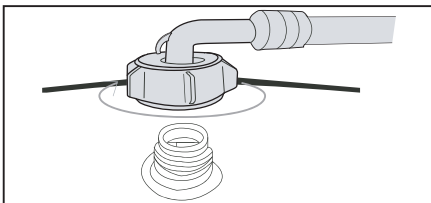

Fig8

3: Ensure all seals are in place before connecting.

Important: Only tighten the hose connection nut by hand - do not overtighten.

Drain hose connections

Important: The height of the top of the curve in the drain hose **MUST** be between 60 - 100cm from the floor. (Fig 9)

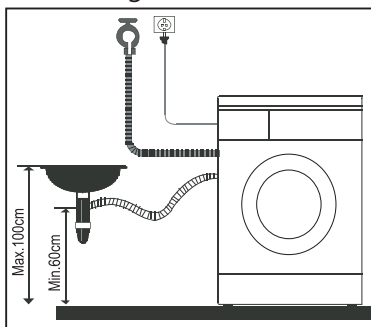

Fig9

Important: Drain hose can be fitted to the drainer or a wash basin.

Electrical



Any electrical work that is required to install this appliance **MUST** be carried out by a qualified electrician.



Warning: THIS APPLIANCE **MUST** BE EARTHED

Before making any electrical connections, ensure that:

- Electrical safety is only guaranteed when the earth system of your house is in accordance with the related local regulations.
- Do not bend, stretch or pull the supply cable to avoid electric shock.
- Ensure the power socket is suitable for the maximum power of the machine (fuses in the power circuit must be 13 amp).
- The supply voltage should be the same as that indicated in the technical specifications and the appliance rating plate.
- The appliance should be earthed and in compliance with the applicable law.
- When installed, the power socket must be within easy reach.
- If the socket outlets in your home are not suitable for the plug supplied with this unit check with a qualified electrician for replacement.
- To avoid the risk of overloading your plug socket, the use of adapters, multiple connectors or extension cables are not recommended.
- The appliance must be connected to a 220-240 volt 50Hz AC supply by means of a three pin socket, suitably earthed and protected by a 13 amp fuse.
- Should the fuse need to be replaced, a 13 amp fuse approved to BS 1362/A must be used.
- The plug contains a removable fuse cover that must be refitted when the fuse is replaced. If the fuse cover is lost or damaged, the plug must not be used until a replacement cover has been fitted or the plug is replaced.
- A damaged plug should be cut off as close to the plug body as possible, the fuse should be removed and the plug disposed of safely.

Installing your washer-drier

Bringing it all together

Plug replacement (UK & Ireland only)

Should you need to replace the plug; the wires in the power cable are coloured in the following way:

Blue - Neutral ' N '

Brown - Live ' L '

Green & Yellow - Earth ' E '

As the colour of the wires in the power cable may not correspond with the coloured markings identifying the terminals in your plug, and proceed as follows (Fig10):

The green & yellow wire must be connected to the terminal in the plug that is marked with the letter E or by the earth symbol.

The blue wire must be connected to the terminal that is marked with the letter N.

The brown wire must be connected to the terminal that is marked with the letter L.

If power supply cord is damaged, it must be replaced by the manufacturer or its service agent or a similar qualified person in order to avoid a hazard.

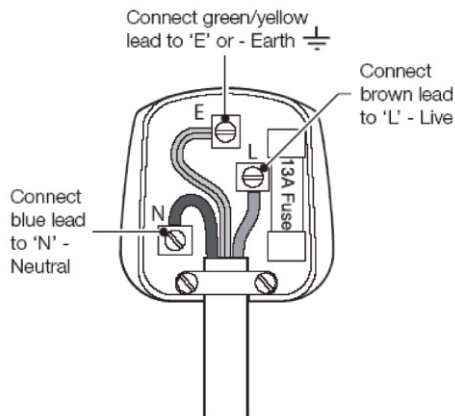

Fig10

Functions 4



Functions

Simple everyday use

Introduction of control panel

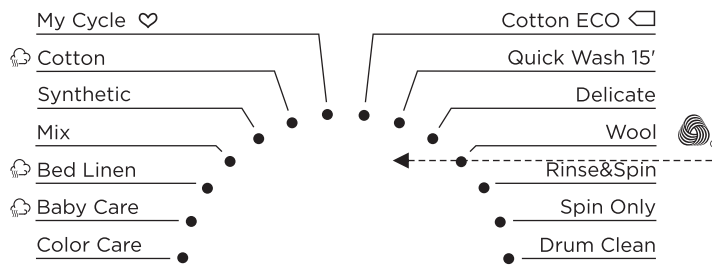

Programmes
Available according to the laundry type.

Display
The display shows the settings, estimated time remaining, options, and status messages for your washer. The display will remain on through the cycle.

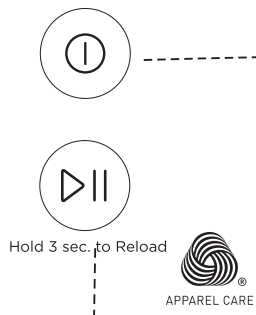
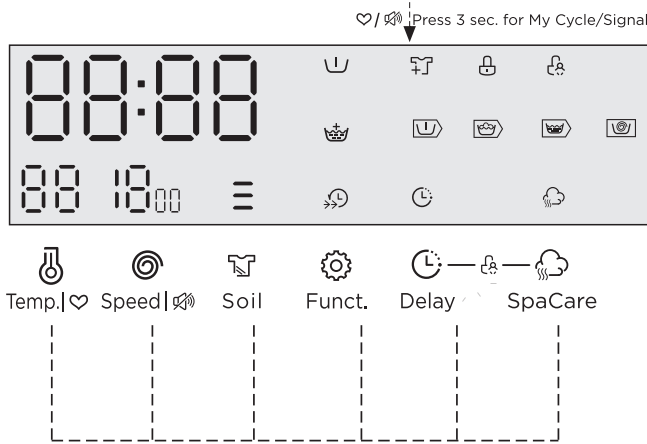

Option
This allows you to select an additional function and will light when selected.

Start/Pause
Press the button to start or pause the washing cycle.

On/Off
Product is switched On/Off.

If you require any technical guidance or find that your product is not operating as intended, a simple solution can often be found in the **Troubleshooting** section of these instructions.

Functions

Simple everyday use

Introduction of control panel

Turning the machine on

Plug in your machine. Place the laundry in the machine and add detergent and softener. Press the "on/off" button.

program selection

First, switch the program knob to select suitable program according to the types of textiles.

Second, select a proper temperature by following the care instructions on the clothes.

Last, select the proper spin speed.

Generally, the higher temperature will consume more energy; the higher spin speed will cause more noise.

PLEASE NOTE: to protect the delicate clothes, the lower spin speed shall be selected.

The main washing procedures depend on the types of the clothes to be washed as follows:

Main program

Depending on the type of textile, the following main programs are available: Each of these main programs comprise of a complete washing process, including washing, rinsing and, if required, spin cycles.

- **Cotton**

Hard-wearing textiles, heat-resistant textiles made of cotton or linen.

- **Synthetic**

Wash synthetic articles, for example: shirts, coats, blending. While washing the knitting textiles, detergent quantity shall be reduced due to its loose string construction and easily forming bubbles.

- **Baby Care**

Washing the baby's clothes, it can make the baby's wear cleaner and make the rinse performance better to protect the baby skin.

- **Mix**

Mixed load consisting of textiles made of cotton and synthetics.

- **Quick Wash 15'**

Extra short programme approx, suitable for lightly soiled washing as a small amounts of laundry.

- **Delicate**

For delicate, washable textiles, e.g. made of silk, satin, synthetic fibres or blended fabrics.

- **Wool**

Hand or machine-washable wool or richwool textiles. Especially gentle wash programme to prevent shrinkage, longer programme pauses (textiles rest in wash liquor).

- **Spin Only**

Extra spin with selectable spin speed.

- **Rinse&Spin**

Extra rinse with spin.

- **Cotton ECO**

To increase the washing effects, washing time is increased.

- **Drum Clean**

Specially set in this machine to clean the drum and tube. It applies 90 °C high temperature sterilization to make the clothes washing more green. When this programme is performed, the clothes or other washing cannot be added. When proper amount of chlorine bleaching agent is put in, the barrel cleaning effect will be better. The customer can use this programme regularly according to the need.

- **Dry Only**

Select it to dry clothes, the temperature is different. The drying time according to the load.

- **1h W/D**

For small synthetic clothes or shirts, load limitation is 1 kg (about 4 shirts).

Functions

Simple everyday use

Program Selection Guide - 8kg washer-drier

Procedure Description	Max. Load(kg) NWDH8XWD	Detergent Box			Delay	Extra Rinse	Prewash	Spa Care	Speed Wash	Soil Level	Max. Water Temp.(°C)	Washing Time (H)	Default.Speed(RPM)
		Case I	Case II	Softener Case								NWDH8XWD	1400
Cotton	8.0/5.0	○	●	○	○	○	○	○	○	○	40	2:40	1400
Synthetic	4.0/4.0	○	●	○	○	○	○	×	×	○	40	2:20	1200
Mix	8.0/5.0	○	●	○	○	○	○	×	○	×	40	1:50	800
Dry Only	6.0	×	×	×	○	×	×	×	×	×	-	4:14	1400
1h W/D	1.0	×	●	○	○	×	×	×	×	×	Cold	0:58	1400
Baby Care	8.0	○	●	○	○	○	○	○	○	○	30	1:20	800
Drum Clean	-	×	×	×	○	×	×	×	×	×	90	1:18	-
Spin Only	8.0	×	×	×	○	×	×	×	×	×	-	0:12	1000
Rinse & Spin	8.0	×	×	○	○	○	×	×	×	×	-	0:20	1000
Wool	2.0	×	●	○	○	○	×	×	×	×	40	1:07	600
Delicate	2.5	×	●	○	○	○	×	×	×	×	30	0:50	600
Quick Wash 15'	2.0	×	●	○	○	×	×	×	×	×	Cold	0:15	800
Cotton ECO	8.0	×	●	○	○	×	×	×	×	×	30	0:55	800

1) The EU energy efficiency class is: A
 Energy test program: Cotton ECO 60.
 Speed: the highest speed; Other as the default.
 Dry energy test program: Dry Only.
 Dry level: Extra Dry

2) "Cotton Eco 60°C" is the standard washing program and "Dry Only" is the standard drying programs to which the information in the label and the fiche relates, and they are suitable to clean normally soiled cotton laundry and that they are the most efficient programmes in terms of combined energy and water consumptions for washing that type of cotton laundry, that the actual water temperature may differ from the declared cycle temperature.

● Means must ○ Means optional × Means not necessary

Note : Water and power consumption and programme duration may differ from the table shown, subject to changes in water pressure, water hardness and temperature, ambient temperature, type and amount of laundry, selection of auxiliary functions, and fluctuations in the supply voltage.

Using your washer-drier

5



Using your washer-drier

Getting the most from your appliance

Organising Laundry

- Read the washing label on each garment to help you sort your washing into different loads.
- Sort the laundry by colour, type of fabric and by how soiled it is. This will help you choose the correct programme and temperature for each wash.

Normal wash Gentle wash 	 Warm wash (max 40°C)	Hand wash Do not wash 	Bleach Do not bleach 	Chlorine bleach may be used Chlorine bleach not be used 	Tumble dry. Medium (max 150°C) Tumble dry. Low heat (max 110°C)
------------------------------------	-----------------------------	----------------------------------	---------------------------------	--	--

Iron Do not iron 	Cool iron(max 110°C) Warm iron,medium (max 150°C) 	Dry clean Do not dry clean 	Dry clean normal cycle with any solvent Dry clean normal cycle petroleum solvent only 	Tumble dry normal Dry flat 	Drip dry Hang to dry /Line dry
-----------------------------	---	---------------------------------------	--	---------------------------------------	--

Iron with cloth Steam Iron 	Dry after wash Line Dry in shade 	Warmly dry clean Do not tumble dry 	Line Dry 	No Wring 	No machine wash
---------------------------------------	---	---	--------------	--------------	---------------------

- Do not exceed the maximum load! See the programme selection table for the maximum load for the programme you require.

Articles / clothes	Approx. weight(g)
Cotton quilt covers (single/double)	900/1500
Bed sheets (single/double)	600/900
Work clothes	1120
Large tablecloths	700
Small tablecloths	350
Tea napkins	100
Bath towels	700
Hand towels	300
Blouses	150
Cotton shirts	300
shirts	180
cotton dresses	500
Jeans	800
Jacket	800
Handkerchiefs	100
T-shirts	150
Shorts	70
Socks	50

Preparing Laundry

- Treat stains before washing.
- Some items should be put into a cleaning net before going into the washer-drier. i.e. bras with metal wires, tights and lace clothing to prevent damage.
- Check that pockets do not contain any objects which may damage your clothes and the washer-drier.
- Tie up any loose strings on laundry, close zippers and reverse clothing with zips inside out.
- To prevent any large, heavy objects (e.g., buckles, large buttons, etc.) from hitting the glass door, turn your clothing inside out, or remove the heavy objects. These could damage your laundry or the washer-drier.
- Remove any surplus hair, animal fur, sand, and other materials with a brush before washing.
- If clothes have raised fabric turn them inside out.
- Clothes that are not colour fast should be washed separately.
- Insert your clothes into the washer-drier.
- Close the washer-drier door. Ensure that you do not trap any items of clothing between the loading door and the rubber seal.

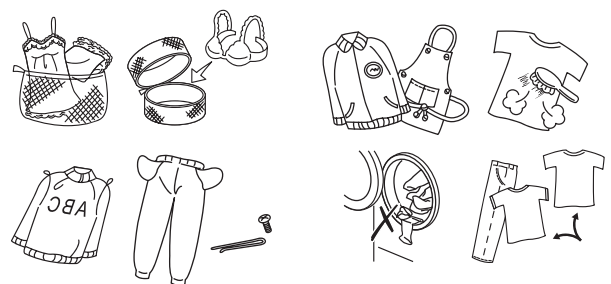

If you require any technical guidance or find that your product is not operating as intended, a simple solution can often be found in the **Troubleshooting** section of these instructions.

Using your washer-drier

Getting the most from your appliance

Adding Detergent and Softener

- Add detergent into the appropriate dispenser.
- Apply softener before you start washing.
- Apply detergent and softener according to the washing amount, the soiling level, the water hardness in your area and the manufacturer's instructions of these products.



Dilute viscous fabric softener and fabric conditioner with water. Prevent blockage of the overflow. Maximum level is 40ml.

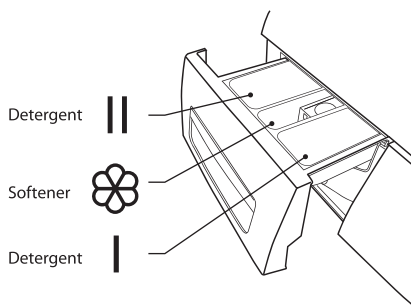

- Do not use the washer-drier when the detergent drawer is removed. It may cause a water leak or it may not work normally.
- If you forget to add detergent, you can drain the washer-drier by running a drain only programme. Then you can add detergent and start the programme again.
- Detergent only reaches the drum when water flushes through the detergent drawer.
- To prevent powder detergent staying in the drawer, dry the inside of the drawer with a cloth. Make sure the powder isn't lumpy when you add it into the drawer.
- If the rinse cycle isn't removing all the detergent from your wash, use less detergent.
- Softener should not exceed the MAX level in the compartment.
Wash out unused softener with a splash of water or a damp cloth after the programme has finished.

Before First Use

- Prior to the first use of the appliance, it is recommended to run a wash programme without clothes. A small amount of washing detergent should be used.

Wash Setting

Standard Washing

1. Pull the door handle and put the laundry in the drum. (Refer to Preparation to sort your laundry before it goes into the drum.) Make sure no washing gets caught in the door.
2. Close the door and press the On/Off button.
3. Turn the Programme selection dial to select your wash programme.
4. Select the temperature if desired.
5. Add detergent into the detergent drawer. The quantity of detergent will depend on the amount of laundry, the degree of soiling and the water hardness. Use the amount of detergent suggested on the packaging.
6. Press the Start/Pause button to start the washing.
7. The washer-drier will sound when the programme is complete.

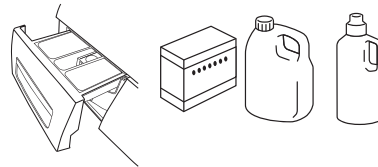

If the door is locked and you switched the washer-drier off and then on - or if there's a power cut - it will stay locked for 1 minute.

Using your washer-drier

Getting the most from your appliance

Removing Washing (Once programme is finished)

 Door remains locked for 1 minute after wash stopped.

- Open the washing machine door and remove your washing.
- Remove any foreign objects to avoid risk of rusting.
- Leave the door and detergent drawer open so that residual water can evaporate.

1.Changing the selection after the program started?

If you need to change a setting after the wash has started, press on/off, then on/off again, Re-select the program, spin speed and optional functions, and then press the Start / Pause button. (Ensure the Child Lock is off, otherwise the original program will continue.)

2.Adding/removing laundry in pause mode?

To press Start/Pause button for 3 seconds, wait until the drum stops rotating. Then the door lock is unlocked, you can add/remove laundry and repress Start/Pause button after close the door.

3.Door lock

The icon lock will light up automatically once the program start. The door lock icon will fade out as soon as the program end and the door will be allowed to open automatically.

4.End of program

It will sound for 5 seconds after the end of program and the display will indicate "end" icon.

Using your washer-drier

Getting the most from your appliance

Quick start

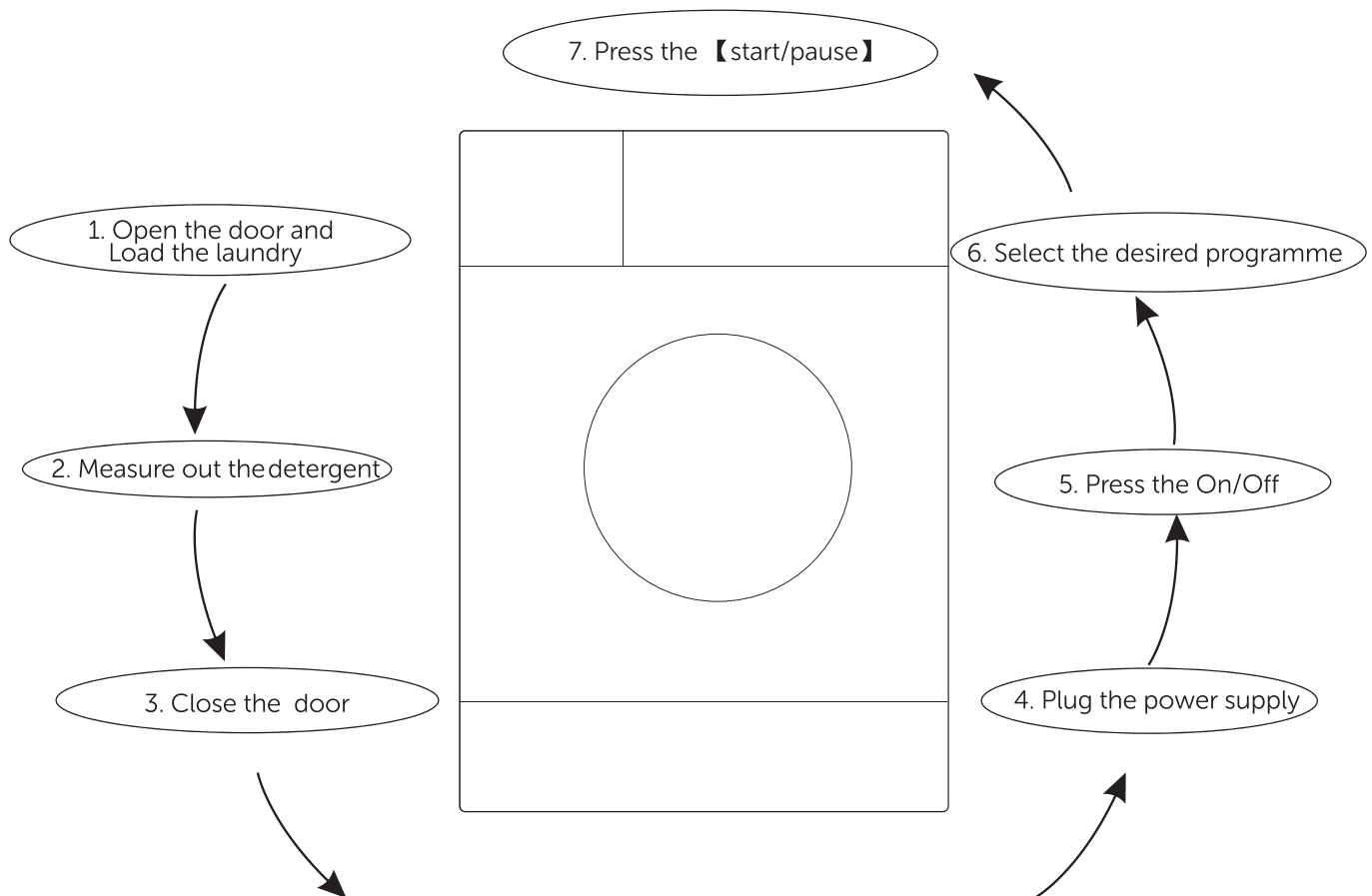

After washing :

- 1.The washer-drier will sound several times for 5 seconds.
- 2.It is recommend to close the water tap and pull out the power plug.
- 3.The machine will empty most of the condensed water from the dryer along with the washer waste water. Only very little water will be remain inside the drum / cavity. The customer can open the door for one or two hours to dry up the remaining water. It is not necessary to remove the water manually.

Care and maintenance

6



Care and maintenance

Looking after your appliance

Before your maintenance starts, please do pull out the power plug or disconnect power and close the tap.



- Do not use solvents clean to avoid that the washer-drier, it will damage, and toxic gases are generated or exploded.
- Do not use the detergents containing PCMX to clean the washer-drier.

Cleaning and Maintenance of Washer-drier Cabinet

- Proper maintenance on the washer-drier can extend its working life. The surface can be cleaned with diluted nonabrasive neutral detergents when necessary. If there is any water overflow, use the wet cloth to wipe it off immediately.

- No sharp items are allowed to strike the cabinet.

Notes: Do not use formic acid and its diluted solvents or equivalent .

Clean Internal Drum

- The rusts left inside the drum by the metal articles shall be removed immediately with chlorine-free detergents.

- Never use steel wool.

Defrost a Frozen Washing Machine

When the temperature drops below zero and your washer-drier gets frozen, you may:

- 1.Disconnect the power supply for the washer-drier.
- 2.Wash the tap with warm water to loosen inlet pipe.
- 3.Take down inlet pipe and immerse it in warm water.
- 4.Pour warm water into washing drum and wait for 10 minutes.
- 5.Reconnect inlet pipe to the tap and check whether inlet and outlet are working normally.

Notes: when the washer-drier is reused, make sure the ambient temperature is above 0 °C

Anti-freeze

If your washer-drier is located in the room where it can get frozen easily, please drain the remaining water inside drain pipe and inlet pipe thoroughly.

Remove the remaining water in inlet pipe:

- 1.Close the tap.
- 2.Screw off the inlet pipe from tap and put its end into the container.
- 3.Start up any procedure except single Wash or Drain procedure. Water will be drained out of inlet pipe if any for about 40 seconds.
- 4.Reconnect the inlet pipe to tap. Remove the remaining water in drain pump(Fig11).

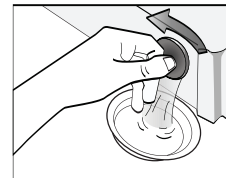

Fig 11

Clean detergent drawer and grooves

- 1.Press down the arrow location on softener cover inside the drawer.
- 2.Lift the clip up and take out softener cover and wash all grooves with water.
- 3.Restore the softener cover and push the drawer into position.

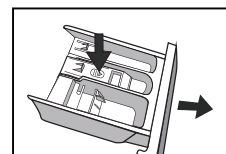

Fig 12

Clean inlet filter

Inlet filter shall be cleaned if there is not any or insufficient water in when the tap is opened.

Clean the tap filter:

- 1.Close the tap.
- 2.Select any procedure except "Wash" or "Drain" procedure.
- 3.Press the button "Start/Pause" and keep the procedure running for about 40 seconds.
- 4.Remove the inlet pipe from the tap.

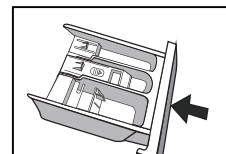

Fig 13

5.Use water to wash the filter.
6.Reconnect the inlet pipe. Washing the filter in washing machine:

- 1.Screw off the inlet pipe from the backside of the machine.
- 2.Pull out the filter with long nose pliers and reinstall it back after being washed.
- 3.Reconnect the inlet pipe.
- 4.Open the tap and make sure there is no water leakage.
- 5.Close the tap.

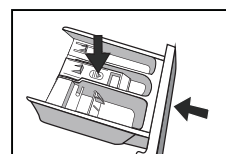

Fig 14

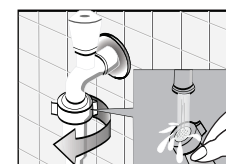

Fig 15

Care and maintenance

Looking after your appliance

Notes: Generally, the tap filter is washed first and then the filter in washer-drier will be washed.

If only the filter in washer-drier is washed, then the steps 1~3 in cleaning the tap filter shall be repeated (Fig16,17) .

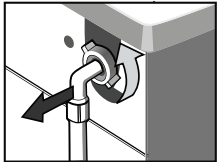

Fig 16

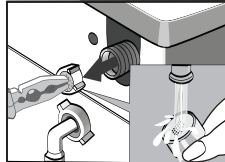

Fig 17



Pull out the power plug to avoid electrical shock before washing.

After using the washer-drier, remove all the clothes and close the door tightly.

Remove foreign matters

Drain Pump Filter:

Drain pump filter can filter the yarns and small foreign matters from the washings.

Clean the filter periodically to ensure the normal operation of washer-drier.

According to the soil level within the cycles and the frequency of the cycles, you have to inspect and clean the filter regularly.

The pump should be inspected if the machine does not empty and/or spin; The machine makes an unusual noise during draining due to objects such as safety pins, coins etc. blocking the pump.

Clean the pump filter :

1. After the power is disconnected, use hand to open the filter cover (Fig18).

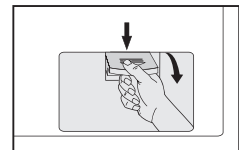

Fig 18

2. Turn the filter down as shown with the figure and take out sundries matters (Fig19) .

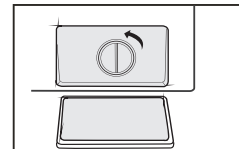

Fig 19

3. Reinstall each part back after sundries matters are removed (Fig20) .

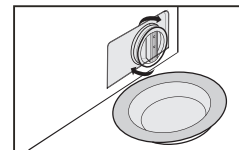

Fig 20

Warning!

When the appliance is in use and depending on the programme selected there can be hot water in the pump. Never remove the filter during a wash cycle, always wait until the appliance has finished the cycle, and is empty. When replacing the filter, ensure it is securely retightened so.

Care and maintenance

Looking after your appliance

Technical specification

Brand	NEW WORLD
Type/Description	NWDH8XWD
Washing/Drying Capacity	8/6kg
Spin Speed	1400 rpm
Energy efficiency class	A
Annual energy consumption always using the driver	1088 kWh/annum
Annual energy consumption never using the driver	176 kWh/annum
Power consumption of off-mode	0.5W
Annual water consumption always using the driver	27200L/annum
Annual water consumption never using the driver	12800L/annum
Spin-drying efficiency class	A
Standard washing cycle	Cotton ECO
Standard drying cycle	Dry Intensive
Energy consumption of the washing cycle	0.88 kWh/cycle
Energy consumption of the drying cycle	4.56 kWh/cycle
Programme duration of standard washing cycle	305 min
Programme duration of standard drying cycle	390 min
Water consumption of the standard washing cycle	64L/cycle
Water consumption of standard drying cycle	72L/cycle
Remaining moisture content of the standard washing cycle	48%
Remaining moisture content of the standard drying cycle	0 %
Noise level of washing	57dB (A)
Noise level of spinning	79dB (A)
Noise level of drying	62dB (A)
Mounting	Free standing
Height	850 mm
Width	595 mm
Depth	465 mm
Power consumption	1900W
Rate voltage/frequency	220-240V~/50Hz
Water pressure	0.05-1 MPa

If you require any technical guidance or find that your product is not operating as intended, a simple solution can often be found in the **Troubleshooting** section of these instructions.

Product support

7



Product support

Help is always at hand

Troubleshooting

1. Washer-drier does not operate ?

You can check if the door is closed tightly, power plug is inserted well and then press start/pause button.

2. Washer-drier does not receive water ?

You can check if the water tap is opened and clean the filters of water inlet hose.

3. Washer-drier is not draining water ?

You can check the drain hose and clean pump filter.

4. Washer-drier is vibrating ?

You can check if the feet are adjusted well and make sure transportation screws are removed.

5. The washing result is poor ?

You can select suitable program and use more detergent.

6. No water is seen in the drum during washing ?

No failure. The water is in the lower part of the drum.

7. There are residues of detergent on the clothes ?

Some detergents contain ingredients which are not soluble in water and which may form white stains on your clothes. Please adjust your machine, carry out an additional rinse, or eliminate the stains after drying, with a brush.

8. There are grey stains on the clothes ?

These stains may be caused by oil, cream or ointment. In the next washing operation, use the maximum detergent amount declared by the detergent producer.

If you require any technical guidance or find that your product is not operating as intended, a simple solution can often be found in the **Troubleshooting** section of these instructions.

Product support

Help is always at hand

Help and assistance

If you require any technical guidance or find that your washer-drier is not operating as intended, a simple solution can often be found in the **Troubleshooting** section of these instructions or online at www.bush-support.com

If you still require further assistance, call one of our experts on **0345 257 7271*** To help give us give you a fast and efficient service please have the following information ready:

Model Ref.	<input type="text"/>	You can find these on the rating plate - a small information panel (usually a sticker or metal plate) on the rear of your appliance
Serial number	<input type="text"/>	
Date of purchase	<input type="text"/>	This will be shown on your receipt

Local call rates applies*

Lines open 8am-7pm Monday to Saturday and 10am-4pm Sunday.

*Calls to Argos enquiry lines may attract a charge and set up fee from residential lines depending on your call plan/tarif. Mobile and other providers costs may vary, see www.bt.com/pricing for details.

For Security and training purposes, telephone calls to and from customer service centres maybe recorded and monitored. Calls from Republic of Ireland will attract international call charges.

or online at www.bush-support.com If you still require further assistance, call one of our experts on **0345 257 7271**.

Product support

Help is always at hand



This appliance complies with the following EEC directives:
2014/35/EU low voltage directive
2014/30/EU EMC directive
96/60/EC EU Directive

Notes on disposal:



This marking indicates that this product should not be disposed with other household wastes throughout the EU. To prevent possible harm to the environment or human health from uncontrolled waste

disposal, recycle it responsibly to promote the sustainable reuse of material resources. To return your used device, please use the collection systems or contact the retailer where the product was purchased. They return and can take this product for environmental safe recycling.

If you require any technical guidance or find that your product is not operating as intended, a simple solution can often be found in the **Troubleshooting** section of these instructions.

Product support

Help is always at hand



Call us now and activate your 12 month guarantee

Thank you for choosing Bush. Your new product is guaranteed against faults and breakdowns for 12 months. Don't forget to register it with us today so we can provide you with our best possible after-sales service and useful updates.

www.bushregistration.co.uk

FREEPHONE*

0800 597 8548

Lines are open 8am - 8pm, 365 days a year. *Calls may be recorded and monitored.

Your Bush Guarantee

This product is guaranteed for twelve months from the date of original purchase. Any defect that arises due to faulty materials or workmanship will be repaired free of charge (or if applicable the product will be replaced or the purchase price refunded) where possible during this period by the dealer from who your purchased the unit.

The guarantee is subject to the following provisions:

- The guarantee does not cover accidental damage, misuse, cabinet parts, knobs or consumable items.
- The product must be correctly installed and operated in accordance with the instructions contained in the manual.
- It must be used solely for domestic purposes. The guarantee will be rendered invalid if the product is re-sold or has been damaged by inexpert repair.
- Specifications are subject to change without notice.
- Bush disclaim any liability for loss or damage arising from the breakdown of the product.
- This guarantee is in addition to and does not diminish your statutory or legal rights.

Important Data Protection Information

To find out how we and Domestic & General Insurance Plc use your data please refer to the guarantee registration material or visit www.bushregistrations.co.uk.

Guarantor: Argos Limited - 489 - 499 Avebury Blvd. - Milton Keynes - MK9 2NW

or online at www.bush-support.com If you still require further assistance, call one of our experts on 0345 257 7271.

You'll soon be enjoying your new washer-drier.

It all begins here, with your instructions. Don't worry, there's nothing too technical coming up. Just simple, step-by-step guidance to get you up and running quickly. Sound good? Then let's get started.

Help and Guidance

We're here to help you get the most from your washer-drier . Should you require any guidance, a simple solution can often be found online at:

www.bush-support.com

If you still require further assistance, call one of our experts on **0345 257 7271**.

BUSH

Contact:

www.bush-support.com

Helpline: 0345 257 7271