

  
newWORLD®



---

INSTRUCTION MANUAL

# REFRIGERATOR

NWBM254

---

## Welcome

Dear users, this manual contains the product's basic knowledge, how to use it, fault diagnosis and basic troubleshooting methods. In order to better understand and use this product, please take good care of this manual and read it carefully.

## Help and Guidance

We're here to help you get the most from your Refrigerator. Should you require any guidance, a simple solution can often be found online at:

[www.newworldassist.co.uk](http://www.newworldassist.co.uk)

If you still require further assistance, call one of our experts on 0333 3052263.

If you require any technical guidance or find that your product is not operating as intended, a simple solution can often be found in the Troubleshooting section of these instructions, or online at [www.newworldassist.co.uk](http://www.newworldassist.co.uk). If you still require further assistance, call one of our experts on 0333 3052263.

## Contents

|       |   |    |
|-------|---|----|
| I.    | Safety Instructions                                 | 4  |
| II.   | Product Features                                    | 8  |
| III.  | Preparations for Use                                | 10 |
| IV.   | Functions   | 12 |
| V.    | Instructions For Food Storage                       | 13 |
| VI.   | Maintenance and Cleaning (Inc Reversing Door Swing) | 16 |
| VII.  | Troubleshooting                                     | 22 |
| VIII. | Certifications                                      | 24 |
| IX.   | Product Support                                     | 25 |
| X.    | Guarantee   | 28 |

\* Varying with Different Products

# I. SAFETY INSTRUCTIONS

 **WARNING:** It is hazardous for anyone other than authorised service personnel to carry out servicing or repairs which involves the removal of covers. To avoid the risk of an electric shock, do not attempt to repair this appliance yourself.



**WARNING:** Risk of fire / flammable materials.

## Safety Warnings and Information

**WARNING:** Do not use electrical appliances such as a hair dryer or heater to defrost your Freezer.

**WARNING:** Containers with flammable gases or liquids can leak at low temperatures.

**WARNING:** Do not store any containers with flammable materials, such as spray cans, fire extinguisher, refill cartridges etc. in the Freezer.

**WARNING:** Do not place carbonated or fizzy drinks in the Freezer compartment. Ice lollies can cause "Frost/Freeze burns" if consumed straight from the Freezer.

**WARNING:** Do not remove items from the Freezer compartment if your hands are damp/wet, as this could cause skin abrasions or "Frost/Freezer burns". Bottles and cans must not be placed in the Freezer compartment as they can burst when the contents freeze.

**WARNING:** Manufacturer's recommended storage times should be adhered to. Refer to relevant instructions.

**WARNING:** Do not allow children to tamper with the controls or play with the appliance.

**IMPORTANT:** The appliance is heavy. Care should be taken when moving it. It is dangerous to alter the specification or attempt to modify this product in any way.

**WARNING:** Do not store flammable gases or liquids inside your Freezer.

**IMPORTANT:** If the power cable is damaged, it must be replaced by the manufacturer, its service agent or similarly qualified persons in order to avoid a hazard.

**WARNING:** This appliance can be used by children aged from 8 years and above and persons with reduced physical, sensory or mental capabilities or lack of experience and knowledge, if they have been given supervision or instruction concerning use of the appliance in a safe way and understand the hazards involved. Children shall not play with the appliance. Cleaning and user maintenance shall not be made by children without supervision.

**IMPORTANT:** This appliance is intended to be used in household and similar applications such as

- staff kitchen areas in shops, offices and other working environments,
  - farm houses and by clients in hotels, motels and other residential type environments,
  - bed and breakfast type environments,
  - catering and similar non-retail applications.
- Keep ventilation openings, in the appliance enclosure or in the built-in structure, clear of obstruction.
  - Do not use mechanical devices or other means to accelerate the defrosting process, other than those recommended by the manufacturer.
  - Do not damage the refrigerant circuit.
  - Do not use electrical appliances inside the food storage compartments of the appliance,

unless they are recommended by the manufacturer.

- Do not store explosive substances such as aerosol cans with a flammable propellant in this appliance.
- This appliance is not intended for use by persons (including children) with reduced physical, sensory or mental capabilities, or lack of experience and knowledge, unless they have been given supervision or instruction concerning use of the appliance by a person responsible for their safety. Children should be supervised to ensure that they do not play with the appliance.

**IMPORTANT:** Keep ventilation openings in the appliance enclosure or in the built-in structure, clear of obstruction.

**WARNING:** Do not use mechanical devices or other means to accelerate the defrosting process, other than those recommended by the manufacturer.

**WARNING:** Do not damage the refrigerant circuit.

**WARNING:** Do not use electrical appliances inside the food storage compartments of the appliance, unless they are of the type recommended by the manufacturer.

**WARNING:** Refrigerating appliances, in particular a refrigerator-freezer, might not operate consistently (possibility of defrosting of contents or temperature becoming too warm in the frozen food compartment), when appliance is running for an extended period of time, below the cold end of the range of temperatures for which the refrigerating appliance is designed.

**WARNING:** It is necessary that, for doors or lids fitted with locks and keys, the keys be kept out of the reach of children and not in the vicinity of the refrigerating appliance, in order to prevent children from being locked inside.

**WARNING:** The refrigerant used in your appliance and insulation materials requires special disposal procedures.

**WARNING:** When positioning the appliance, ensure the supply cord is not trapped or damaged.

**WARNING:** Do not locate multiple portable socket-outlets or portable power supplies at the rear of the appliance

Children aged from 3 to 8 years are allowed to load and unload refrigerating appliances.



To avoid contamination of food, please adhere to the following instructions:

- Opening the door for long periods can cause a significant increase of the temperature in the compartments of the appliance.
- Clean regularly surfaces that can come in contact with food and have accessible drainage systems.
- Clean water tanks if they have not been used for 48 hours, flush the water system connected to a water supply if water has not been used for 5 days.
- Store raw meat and fish in suitable containers in the refrigerator, so that it is not in contact with or drip onto other food.
- Two-star frozen food compartments are suitable for storing pre-frozen food, storing or making ice-cream and making ice cubes.
- One, two and three-star compartments are not suitable for the freezing of fresh food.
- If the refrigerating appliance is left empty for long periods of time, switch off, defrost, clean, dry, and leave the door open to prevent mould developing within the appliance.

## Electrical Supply Connection

- Connect the appliance to the electrical supply (220-240 V ~ 50 Hz) with the plug and lead, which are fitted.
- Connections to the mains supply should be in accordance with local regulations.
- DO NOT use plug adapter.
- The appliance must be plugged into an earthed socket
- Always make sure that the plug is accessible after the appliance has been positioned.
- If the electrical cable is damaged or worn, turn off the refrigerator and consult an authorised agent for replacement.

## Electrical Safety

- ⚡  **WARNING:** When positioning the appliance, ensure the supply cord is not trapped or damaged.
- ⚡  **WARNING:** DO NOT locate multiple portable socket-outlets or portable power supplies at the rear of the appliance  
DO NOT use plug adapter.
- ⚡  **WARNING:** Risk of fire / flammable materials

- The plug must be accessible after installation.
- The operating voltage for your appliance is 220-240 V at 50Hz.
- Connections to the mains supply should be in accordance with local regulations.
- Insert the plug into a socket with an efficient ground connection. If the socket has no ground contact or the plug does not match, we recommend you consult a qualified electrician for assistance.
- The appliance must be connected with a properly installed fused socket. The power supply (AC) and voltage at the operating point must match with the details on the name plate of the appliance (the name plate is located on the inside left of the appliance).
- The appliance must be plugged into an earthed socket.
- The plug MUST be accessible after the appliance has been positioned. The cord should be secured and not left exposed or dangling to prevent accidental injury.
- The appliance is supplied with a standard three-pin plug, of which the one for grounding should never be removed.
- Hold the plug, not the electrical cable, when unplugging the appliance.
- Make sure that the appliance does not trap the electric cable.
- DO NOT step on the cable.
- Avoid damage to the electric cable when moving the appliance.
- This refrigerator appliance is not designed to be used with an inverter.

DO NOT use an extension cord with this appliance. If the power cord is too short, have a qualified electrician or service technician install an outlet near the appliance. Use of an extension cord can negatively affect the performance of the unit.

**WARNING:** Improper use of the grounded plug can result in the risk of electrical shock. If the power cord is damaged, have it replaced by an authorised service provider.

## Climate Range

The information about the climate range of the appliance is provided on the rated plate. It indicates at which ambient temperature (that is, the room temperature in which the appliance is working) the operation of the appliance is optimal (proper).

| Climate range | Permissible ambient temperature |
|---------------|---------------------------------|
| SN            | from +10°C to +32°C             |
| N             | from +16°C to +32°C             |
| ST            | from +16°C to +38°C             |
| T             | from +16°C to +43°C             |

Note: Given the limit values of the ambient temperature range for the climate classes for which the refrigerating appliance is designed, and the fact that the internal temperatures could be affected by such factors as location of the refrigerating appliance, ambient temperature and the frequency of door opening, the setting of any temperature control device might have to be varied to allow for these factors, if appropriate.

## Freon-free

The freon-free refrigerant (R600a) and the foaming insulation material (cyclopentane) are used for this refrigerator and are environmentally friendly, causing no damage to the ozone layer and having very small impact on global warming. R600a is flammable, and sealed in a refrigeration system, without leakage during normal use. In the case of refrigerant leakage due to the refrigerant circuit being damaged, be sure to keep the appliance away from open flames and open the windows for ventilation as quickly as possible.

## II. Product Features

This fridge-freezer is equipped with electronic temperature controls. Its top compartment for fresh food storage, such as fruits, vegetables, eggs, milk, cooked foods, etc, and its bottom freezer compartment where fish, meat, etc. can be frozen for long-term storage.

- **Display**

Within the cabinet of the fridge compartment is an electronic temperature control panel. This is used to control the temperature/mode of your fridge/freezer.

- **Green technology**

The freon-free refrigerant and foaming insulation materials are used for this fridge-freezer, causing no damage to the ozone layer and having a very small impact on global warming, therefore the fridge is an environmentally friendly product.

- **Reversible Doors**

The doors of the fridge/freezer have been designed to have the ability to be hinged from either the right or left side. (Instructions on how to reverse the door can be found on pages 19–21).

- **Smart Frost Technology**

Reduces ice formation to minimise the frequency of having to defrost the freezer. The evaporator is built into the outside structure of the freezer, rather than via the traditional grilles found in most freezers. This not only reduces the amount of ice formed but makes it easier to remove from the flat surfaces of the walls and top of the freezer cavity.



## Refrigerator Diagram

Note: Due to technological innovation, the product descriptions in this manual may not be completely consistent with your refrigerator. Details are in accordance with the real product.

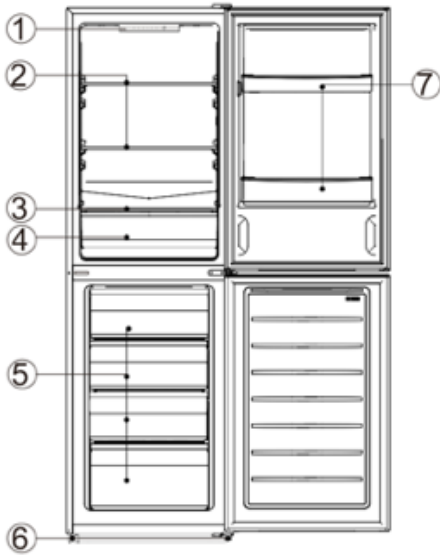

## NWBM254

- 1 Thermostat
- 2 Refrigerator Glass Shelf
- 3 Crisper Cover
- 4 Crisper
- 5 Frozen Drawer
- 6 Adjusting foot
- 7 Bottle frame

### III. Preparations for use

#### Installation location:

##### 1. Ventilation condition

When installing your refrigerator, ensure it is in a well ventilated location. Do not install the refrigerator near any heat source such as a cooker. Avoid locating the refrigerator in direct sunlight, this will ensure you reduce the energy consumption of the appliance. Do not locate the refrigerator in a damp place, this will prevent the refrigerator from rusting and leaking electricity.

The result of the total space of the room in which the refrigerator is installed being divided by the refrigerant charge amount of the refrigerator shall not be less than 8 g/ M3.

Note: The amount of refrigerant charged for the refrigerator can be found on the nameplate.

##### 2. Heat dissipation space

When your refrigeration is installed and running, it will give off heat to it's surroundings. Therefore, a minimum of 300mm free space should be at the top of the unit, minimum of 100mm on both sides, and a minimum of 50mm at the back of the refrigerator.

Dimensions in mm:

| W   | D   | H    | A   | B    | C(°) | E  | F   |
|-----|-----|------|-----|------|------|----|-----|
| 540 | 550 | 1760 | 910 | 1055 | 135  | 50 | 100 |

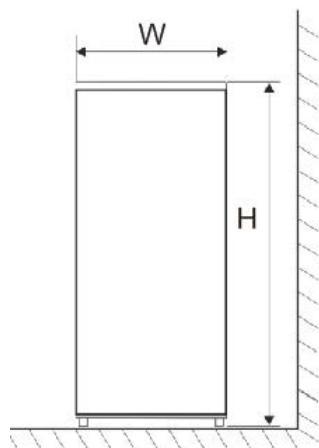

Fig. 1

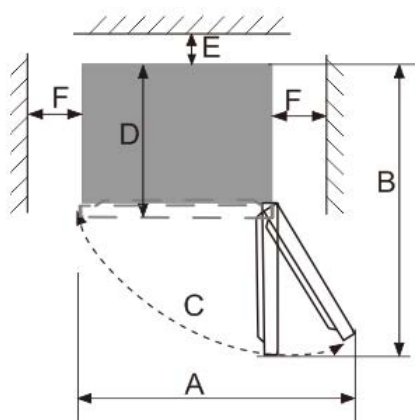

Fig. 2

Note: Figure 1, Figure 2 only illustrate the space demand of the product.

### 3. Level ground

Place the refrigerator on a solid and flat ground (floor) to keep it stable, or else it will give rise to vibration and noise.



Unobstructed ventilation shall be maintained around the appliance or in an embedded structure.

## Preparations for use

### 1. Standing time

After the refrigerator is properly installed and well cleaned, do not switch it on immediately. Make sure you allow a minimum of 4 hours before turning on the power of the refrigerator.

### 2. Cleaning

Before use ensure you clean the internal compartments and all shelves and accessories with a soft cloth.

### 3. Power-on

Insert the plug into the power socket to start the compressor. After 1 hour, open the freezer door, if the temperature inside the freezer compartment drops obviously, it indicates the refrigeration system is working normally.

### 4. Storage of food

After the refrigerator runs for a period of time, the internal temperature of the refrigerator will be automatically controlled according to the user's temperature setting. After the refrigerator is fully cooled, put in foods, which usually need 2~3 hours to be fully cooled. In summer, when the temperature is high, it takes more than 4 hours for the foods to be fully cooled (Try to open the refrigerator door as less as possible before the internal temperature cools down).

If the refrigerator is installed in a moisture filled room, make sure to check whether the ground wire and leakage circuit breaker are normal. If vibration noises are produced due to the refrigerator making contact with the wall, or if the wall gets blackened by air convection around the compressor, move the refrigerator away from the wall. Setting up the refrigerator may cause jamming noise or image chaos to mobile phones, fixed-line telephone, radio receiver, television sets surrounding it, so try to keep the refrigerator as far away as possible from these items.

## IV. Functions

The Temperature of the refrigerator is controlled by the control panel mounted inside the fridge compartment.

### Temperature Setting

1. Under normal operating conditions (Spring and Autumn), it is recommended to set temperature mode to between 5-8.
2. In Summer, when the ambient temperature is high, it is recommended to set the temperature mode between 2-4.
3. In Winter when the ambient temperature is low, it is recommended to set your temperature controls to between 2-4.
4. Fast Cool: When this function is enabled, the fridge and freezer temperature can be reduced rapidly at the same time. This will ensure food is kept in the freshest conditions without the loss of any nutrients. The maximum running time of the fast cool function is 26 hours, after which the refrigerator will be restored to its previous mode that it was set to before the fast cool function was enabled.



NOTE: If the indicator light '2' or '5' flicker, it indicates that the refrigerator has broken down. Please contact the after sales service center as soon as possible.

## V. Instructions for food storage

### Precautions for use

- The appliance might not operate consistently (if there is a possibility of defrosting or temperature becoming too warm in the frozen food compartment) when running for an extended period of time below the cold limit of the temperature range for which the refrigerating appliance is designed
- The information of climate type of the appliance is provided on the rating plate.
- The internal temperature could be affected by such factors as, the location of the appliance, ambient temperature, and frequency of door being opened, etc., and if appropriate, the setting of any temperature control device might have to be varied to allow for these factors should be made.
- Effervescent drinks should not be stored in the freezer compartment or the low-temperature compartment, and some products such as water ices should not be consumed too cold.

### Food storage location

Due to the cold air circulation in the refrigerator, the temperature of each area in the refrigerator is different, so different kinds of food should be placed in different areas. The fresh food compartment is suitable for the storage of foods that do not require to be frozen, as well as cooked food, beer, eggs, some condiments that need cold preservation, milk, fruit juice, etc. The crisper box is suitable for the preservation of vegetables, fruits, etc. The freezer compartment is suitable for the storage of ice cream, frozen food and the foods to be preserved for a long period of time.

### Use of the fresh food compartment

Set the temperature of the fresh food storage compartment between 2°C & 8°C , and store the foods that are intended for short-term storage, or to be eaten at any time in the fresh food compartment.

Fridge shelf: When removing the shelf, lift it up first, and then pull it out; and when installing the shelf, place it into position before putting it down. Keep the shelf rear flange upward, to prevent foods from contact of fridge wall. When taking out or putting in the shelf, hold it firmly, and handle with care to avoid damage.

Crisper box: Pull out the crisper box for access to food. After using or cleaning the cover plate of the crisper box, be sure to put it back onto the crisper, so that the internal temperature of the crisper box will not be affected.

### Use of the crisper humidity regulating rod (If applicable)

The humidity regulating rod of the crisper box is designed to maintain the humidity and freshness of the vegetables stored inside.

When the humidity regulating rod is slid to the right, with more holes exposed, lower humidity will be kept inside the crisper box.

When the humidity regulating rod is slid to the left, with less holes exposed, higher humidity will be kept inside the crisper box.

### Cautions for food storage

Before foods are put in the refrigerator, it is advisable to seal them, to prevent water

evaporation. Keep fresh fruits and vegetables on one section, this will help to prevent taint of odor in other sections of the refrigerator.

Do not over crowd the refrigerator. Keep enough space between foods because if foods are too close, the cold air flow will be blocked, thus affecting the refrigeration effect. Do not store excessive or overweight foods, to avoid the shelf from being crushed. When storing the foods, keep a distance away from the inner wall; and do not place the water-rich foods too close to the fridge rear wall, as there will be a risk of them becoming frozen to the inner wall.

### **Categorised storage of foods**

Foods should be stored by category, with the foods you eat every day placed in front of the shelf, so that the door open duration can be shortened and food spoilage due to expiration can be avoided.

Energy-saving tips: Allow hot food to cool down to the room temperature before putting it in the refrigerator. Put the frozen food in the fresh food compartment to thaw, using the low temperature of the frozen food to cool the fresh food, thus saving energy.

Use of the frozen food storage compartment

The freezer temperature is controlled below  $-18^{\circ}\text{C}$ , and it is advisable to store the food for long-term preservation in the freezer compartment, but the storage duration indicated on the food packaging should be adhered to.

The freezer drawers are used to store food that needs to be frozen. Fish and meat of large block size should be cut into small pieces and packed into fresh-keeping bags before they are evenly distributed inside the freezer drawers.

### **Tips for Fridge/freezer storage**

- Allow the hot foods to cool down to the room temperature before putting them in the freezer compartment.
- Do not put a glass container with liquid or the canned liquid that is sealed in the freezer compartment, to avoid it bursting due to volume expansion after the liquid becomes frozen.
- Divide foods into smaller portions for freezing.
- Before freezing foods, ensure packing/bag used should be dry, this avoids the packaging/bags sticking together frozen.
- To avoid contamination and odour transfer, foods should be packed and/or covered by suitable materials. Eg firm, tasteless, impervious to air and water, non-toxic and pollution-free.

## Moving your Fridge/Freezer

- **Location**

Do not place your refrigerator/freezer near a heat source, e.g. cooker, boiler or radiator. Avoid it from direct sunlight in out-buildings or sun lounges.

- **Leveling**

Make sure to level your refrigerator/freezer using the front leveling feet. If not level, the refrigerator/freezer door gasket and sealing performance will be affected, or it may lead to the operating failure of your refrigerator/freezer.

After locating the refrigerator/freezer in position, wait for 4 hours before using it, to allow the refrigerant to settle.

- **Installation**

Do not cover or block the vents or grills of your appliance.

NOTE:

- If the appliance will not be used for several months, turn it off first, and then unplug the plug from the wall outlet.
- Take out all food.
- Clean and dry the interior thoroughly. To prevent odor and mold growth, leave the door ajar.
- Keep the cleaned appliance in a dry, ventilated place and away from the heat source, and do not place heavy objects on top of it.
- The unit should not be accessible to children's play.

## VI. Maintenance and cleaning



Before cleaning, turn off power first then unplug the appliance from the wall socket. Do not plug in or pull plug out with wet hands, because there is a risk of electric shock and injury.

Do not spill water directly on the refrigerator, to avoid rust, electricity leakage and accidents.

Do not stretch your hands into the bottom of the refrigerator, you might be scratched by sharp metal corners.

### Internal Cleaning and External Cleaning

The food residuals in the refrigerator are liable to produce bad odor, so the refrigerator must be cleaned regularly.

The fresh food compartment should be cleaned once a month.

Remove all shelves, crisper box, bottle racks, cover board, and drawers etc, and clean them with a soft towel or sponge dipped in warm water or neutral detergent.

Clear off the dusts accumulated on the rear panel and side plates of the refrigerator often.

After using detergent, be sure to rinse it with clean water, and then wipe it dry.



Do not use bristle brushes, steel wire brushes, detergent, soap powder, alkaline detergent, benzene, gasoline, acid, hot water and other corrosive or soluble items to clean the cabinet surface, door gasket, plastic decorative parts, etc, to avoid damage.

- Take care of the frozen foods in the event of an extended non-running of the refrigerating appliance (such as interruption of power supply or failure of the refrigerating system).
- Try to open the refrigerator door as less as possible, to ensure food safety and food is kept fresh for hours even in the hot summer.
- If you get the power outage notice in advance:
  - 1) Adjust the thermostat knob to the high mode an hour in advance, so that foods get fully frozen (Do not store new food during this time!). Restore the temperature mode to the original setting when power supply becomes normal in a timely manner.
  - 2) You can also make ice with a watertight container, and put it in the upper part of the freezer, so as to extend the time for fresh food to be stored.



Note: Once the refrigerator is powered on and in use, it is best to use the fridge/freezer continuously under normal circumstances to ensure not to affect the service life of the appliance.



## Defrosting

After a period of use, a thin layer of frost will be formed on the freezer compartment inner wall (or evaporator) surface, which may affect the refrigeration performance if exceeding 5mm in thickness. In such case, you need to gently scrape the frost off using an ice scraper rather than the metal or sharp object. Frost needs to be cleared off every 3 months, or if the frost is affecting the normal use of the drawers and or the refrigeration performance. Follow the following steps to remove frost:

1. Take out the frozen foods, shut off the mains power supply, open the refrigerator door, and gently remove the frost from the inner wall with an ice scraper. To speed up the thawing process, it is suggested to place a bowl of hot water inside the refrigerator/freezer, and when the solid ice particles become loose, use an ice scraper to remove from surface.
2. After defrosting, clean the fridge/freezer inside, and switch on the power supply.

## Changing the lamp

The LED lamp is used by the refrigerator for lighting, which features low energy consumption and long service life. In case of any abnormality or if you need to replace the lamp, please contact the after sales service center on 0333 3052263

### Safety-check after maintenance

Is the power cord broken or damaged? If yes, contact your after sales service centre

Is the power plug firmly inserted into the socket?

Is the power plug abnormally overheated? If yes, contact your after sales service centre



Note: Electric shock and fire accident may be caused in case the power cord and plug is damaged or stained by dust. If any abnormality, please switch power off to the appliance and then unplug the power plug and get in contact with the the service provider.

### How to Disassemble Bottle Racks and Fridge Shelves.

- Fridge door bottle rack:  
Hold the bottle rack with both hands, and then push it up.

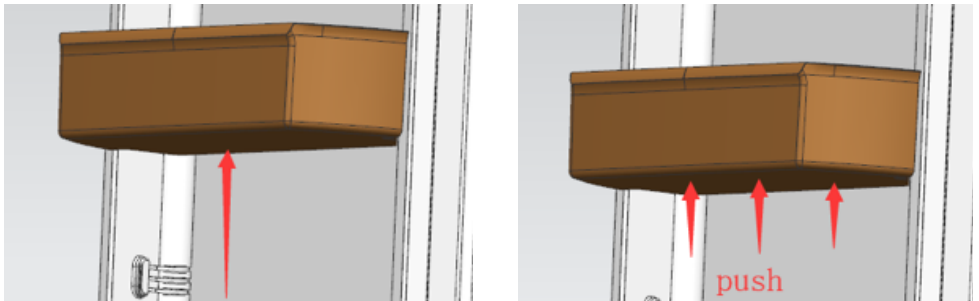

- Fridge shelf:  
Hold one end of the shelf, lift it up whilst pulling it outwards.

## Reversing the Door Swing

1. Make sure that your refrigerator is unplugged.
2. Pry the hinge cover up and off, remove the three screws that secure the upper hinge to the door, then remove the hinge.

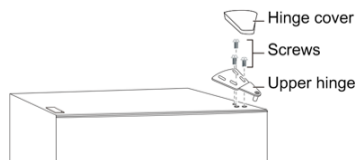

3. Remove the refrigerator compartment door from the cabinet.
4. Remove the two screws that secure the center hinge.

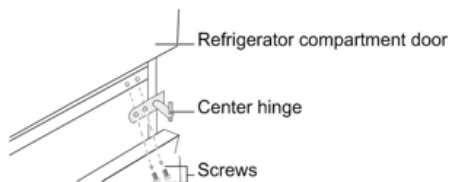

5. Remove the freezer compartment door.
6. Remove the screws that secure the lower hinge to the right side of the cabinet, then remove the hinge.

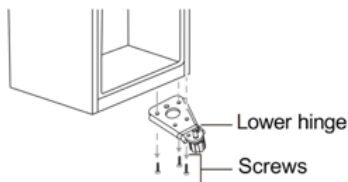

7. Remove the washer and nut that secure the pin shaft to the right hole on the lower hinge, then remove the shaft.

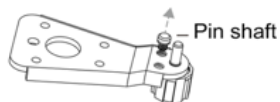

8. Insert the pin shaft into the left hole on the lower hinge, then secure the shaft with the washer and nut.
9. Install the lower hinge on the left side of the cabinet.
10. Remove the screw that secures the door stop from the bottom right of the freezer compartment door, then remove the door stop and install to the bottom left side.



11. Install the freezer compartment door.
12. Move the door bushing from the top right side of the freezer door to the top left side of the door. And move the left hole cover to the right side.

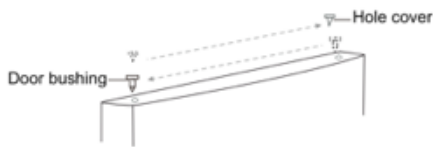

13. Remove the center hinge screw hole plug on the left side of the cabinet, then install in the screw holes on the right side of the cabinet.



14. Install the center hinge to the left side with the two screws you removed previously.

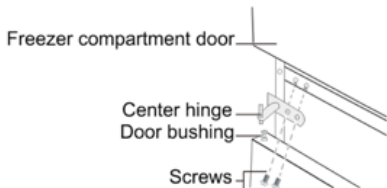

15. Get the left door stop from the accessory bag, install it on the bottom left side of the refrigerator door.

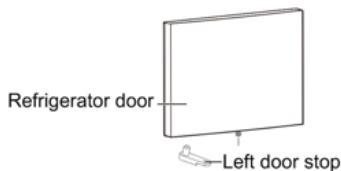

16. Install the Refrigerator compartment door.
17. Move the door bushing from the top right side of the Refrigerator door to the top left side of the door. And move the left hole cover to the right side.

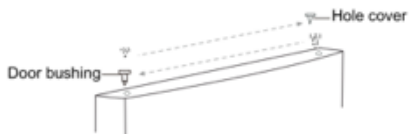

18. Remove the screw that secures the hinge screw hole cover from the top left side of the cabinet, remove the cover and secure the cover on the top right side of the cabinet.

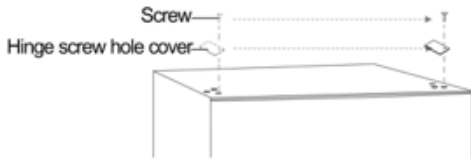

19. Secure the upper hinge to the top left side of the cabinet with the three screws you removed previously. Before you tighten the upper hinge screws, make sure that the top of the door is level with the cabinet and that the rubber gasket makes a good seal.

20. Install the hinge cover over the hinge on the top left side of the cabinet.

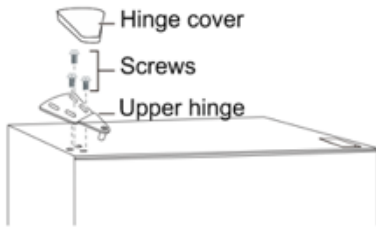

## VII. Trouble Shooting

With regard to the following small faults, not every failure needs to be fixed by the technical service personnel; you can try to solve the problem by referring to table below.

| CASE                           | INSPECTION  | SOLUTIONS  |
|--------------------------------|---|--|
| Completely non- refrigeration  | <ul style="list-style-type: none"><li>• Is power plug off?</li><li>• Are breakers and fuses broken?</li><li>• No electricity or line trip?</li></ul>  | <ul style="list-style-type: none"><li>• Re-plug</li><li>• Opening the door and checking whether the lamp is lit.</li></ul>   |
| Abnormal noise                 | <ul style="list-style-type: none"><li>• Is refrigerator stable?</li><li>• Does refrigerator make contact with the wall?</li></ul>   | <ul style="list-style-type: none"><li>• Adjusting refrigerator's leveling feet.</li><li>• Move appliances further away from the wall.</li></ul>  |
| Poor refrigerating efficiency  | <ul style="list-style-type: none"><li>• Do you put hot food or too much food in the fridge?</li><li>• Do you open the door frequently?</li><li>• Is the fridge in direct sunlight or near a furnace or stove?</li><li>• Is it well-ventilated?</li><li>• Temperature setting in too high?</li></ul> | <ul style="list-style-type: none"><li>• Putting food into refrigerator when hot food reached room temperature.</li><li>• Checking and closing the door.</li><li>• Relocate the refrigerator away from heat source.</li><li>• Relocate fridge to location which has good ventilation.</li><li>• Change setting to an appropriate temperature.</li></ul> |
| Peculiar smell in refrigerator | <ul style="list-style-type: none"><li>• Any spoiled food?</li><li>• Do you need to clean refrigerator?</li><li>• Have you packed food of strong flavors?</li></ul>  | <ul style="list-style-type: none"><li>• Throw away spoiled food.</li><li>• Clean refrigerator. (Recommended regularly)</li><li>• Seal foods of strong flavors.</li></ul>   |



Note: If the trouble shooting advice does not resolve your problem, do not attempt to disassemble or repair this appliance. Repairs carried out by an inexperienced person may cause injury or serious malfunctioning. Contact your after sales service provider. This product should be serviced by an authorised engineer with only genuine spare parts.

When the appliance is not in use for long periods, disconnect from the electricity supply, empty all foods and clean the appliance, leaving the door ajar to prevent unpleasant smells and mould.

## VIII. Certifications

### Electrical information

This electrical appliance must be grounded.

This product is equipped with a plug, which is suitable for all houses equipped with sockets meeting the current specifications.

If the fitted plug is not suitable for your socket outlets, it should be cut off and carefully disposed of by a qualified electrician. To avoid a possible shock hazard, do not insert the discarded plug into a socket.

This product complies the EEC directives.



# IX. Product Support

## Declaration of conformance to product standards

This appliance conforms to all relevant standards applicable to domestic appliances sold in the UK

## Disposal



This appliance/fitting is marked A according to the European directive 2012/19/EU on Waste Electrical - and Electronic Equipment (WEEE). By ensuring this product is disposed of correctly, you will help prevent potential negative consequences for the environment and human health, which could otherwise be caused by inappropriate waste handling of this product.

The symbol on the product, or on the documents accompanying the product, the crossed out wheeled bin symbol, indicates that this appliance/fitting may not be treated as household waste. Instead it shall be handed over to the applicable collection point for the recycling of electrical and electronic equipment. Disposal must be carried out in accordance with local environmental regulations for waste disposal.

For more detailed information about treatment, recovery and recycling of this product, please contact your local authority, your household waste disposal service or the retailer where you purchased the product.

Old fridges and freezers contain isolation material and refrigerant with CFC. Therefore, take care not to harm the environment when you are discarding your old fridges.





## X. Guarantee

### Activate your 24 month guarantee

Thank you for choosing New World. Your new product is guaranteed against faults and breakdowns for 24 months. Don't forget to register it with us today so we can provide you with our best possible after-sales service and useful updates.

[www.newworldassist.co.uk](http://www.newworldassist.co.uk)

Or call 0333 3052263

### Your New World Guarantee

This product is guaranteed for 24 months from the date of original purchase. Any defect that arises due to faulty materials or workmanship will be repaired free of charge (or if applicable the product will be replaced or the purchase price refunded) where possible during this period by the dealer from who you purchased the unit.

The guarantee is subject to the following provisions:

- The guarantee does not cover accidental damage, misuse, cabinet parts, knobs or consumable items.
- The product must be correctly installed and operated in accordance with the instructions contained in the manual.
- It must be used solely for domestic purposes. The guarantee will be rendered invalid if the product is re-sold or has been damaged by inexpert repair.
- Specifications are subject to change without notice.
- New World disclaim any liability for loss or damage arising from the breakdown of the product.
- This guarantee is in addition to and does not diminish your statutory or legal rights.

### Important Data Protection Information

To find out how we use your data please refer to the guarantee registration material or visit [www.newworldassist.co.uk](http://www.newworldassist.co.uk)

